

Disc technical data

Diameter (Diameter)
374 mm

Overall height (A)
66,1 mm

Centring diameter (B)
75 mm

Number of holes (C)
5

Thickness (TH)
36 mm

Minimum thickness
34,4 mm

Tightening torque
Nm

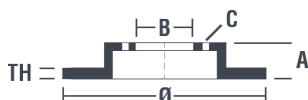

Brand part numbers

Brembo
09.C408.13

AP
25518 Z

Breco
BZ 9128

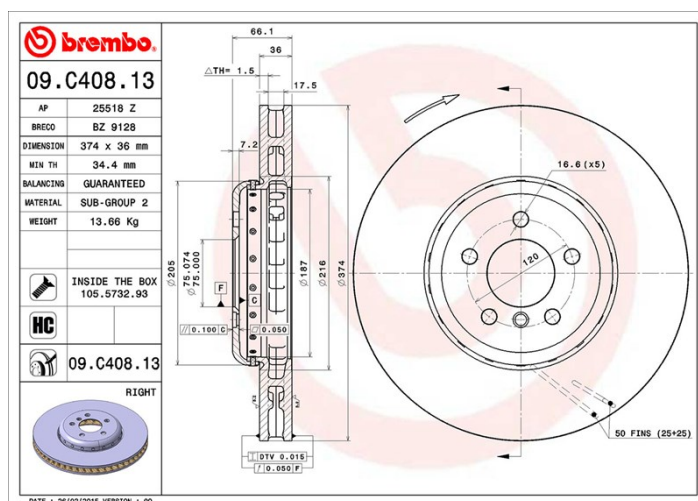

Technical specifications

High Carbon disc (HC)

Thanks to the high percentage of carbon in the chemical composition of the cast iron, the HC disc provides greater damping coefficient, able to reduce vibration and noise while driving.



Disc with fixing screw

By supplying the fixing screw in the disc box, Brembo provides extra help to the mechanic if the original screw is rusty or worn to such an extent as to prevent or make it difficult to reuse.



UV Disc

The UV coating process provides a superior corrosion resistance and full disc protection.



Compatible vehicles

BMW

Model	Type	Kw	Year
5 (F10)	550 i	300	01/09 06/13
5 (F10)	550 i	330	08/12 10/16
5 (F10)	550 i xDrive	330	01/13 10/16
5 (F10)	550 i xDrive	300	08/10 06/13

5 (F10)	M 550 d xDrive	280	07/11 10/16
5 Gran Turismo (F07)	550 i xDrive	300	04/09 06/12
5 Gran Turismo (F07)	550 i xDrive	330	04/11 -
5 Touring (F11)	550 i	330	08/12 -
5 Touring (F11)	550 i	300	09/10 06/13
5 Touring (F11)	M 550 d xDrive	280	10/10 -
6 Convertible (F12)	650 i	300	03/11 -
6 Convertible (F12)	650 i	330	10/11 -
6 Convertible (F12)	650 i xDrive	300	06/11 -
6 Convertible (F12)	650 i xDrive	330	11/11 -
7 (F01, F02, F03, F04)	740 i	240	10/08 12/15
7 (F01, F02, F03, F04)	750 d xDrive	280	07/12 12/15
7 (F01, F02, F03, F04)	750 i	300	10/08 12/15
7 (F01, F02, F03, F04)	750 i	330	10/12 12/15
7 (F01, F02, F03, F04)	750 i xDrive	300	09/09 12/15
7 (F01, F02, F03, F04)	750 i xDrive	330	10/12 12/15
7 (F01, F02, F03, F04)	ActiveHybrid	330	09/09 06/12
7 (F01, F02, F03, F04)	ActiveHybrid	342	09/09 06/12

OE Part number

Compatible OE codes

BMW	34116785676
-----	-------------